

ELEMENTI BACK OFFICE

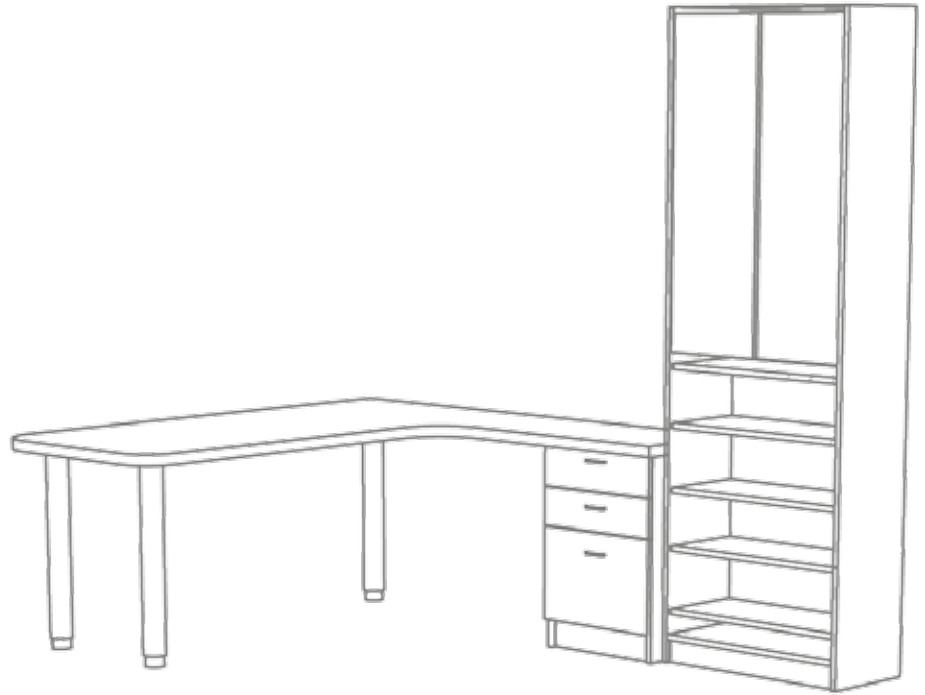



MOBILETTI
pag. 4-5



MOBILE HOME0
pag. 6-7



ARMADI
pag. 8-11



PARETE CON RIPIANI REGOLABILI
pag. 12-13



SCRIVANIE
pag. 14



BANCHI GALENICI
pag. 15

COLORI:



BP
BIANCO



GP
GRIGIO ANTRACITE



cod.BOFA007



MOBILE DI BASE CON
3 CASSETTI PICCOLI
E 1 CASSETTO
GRANDE
60x60 H91

cod.BOFA008



MOBILE DI BASE
CON 2 CASSETTI
PICCOLI E 2
CASSETTI GRANDI
60x60 H91

cod.BOFA009



MOBILE DI BASE CON
2 CASSETTI, 1 PIANO
SPOSTABILE E 1 PIANO
ESTRAIBILE
60x60 H91

cod.BOFA010

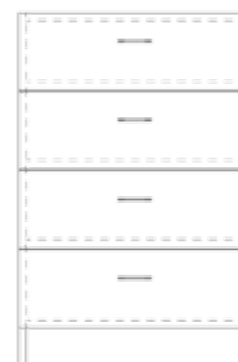

MOBILE DI BASE
CON 4 CASSETTI
60x60 H91

cod.BOFA011



MOBILE DI BASE
CON 5 CASSETTI
60x60 H91

cod.BOFA012



MOBILE DI BASE
CON 6 CASSETTI
60x60 H91

cod.BOFA001



MOBILE PENSILE
CON 1 ANTA E 1
PIANO SPOSTABILE
60x37 H50

cod.BOFA002



MOBILE PENSILE
CON 1 ANTA E 1
PIANO SPOSTABILE
50x37 H50

cod.BOFA003



MOBILE PENSILE CON 2
ANTE E 1
PIANO SPOSTABILE
100x37 H50

cod.BOFA004



MOBILE DI BASE CON
1 CASSETTO E 1 PIANO
SPOSTABILE
60x62 H91

cod.BOFA005



MOBILE DI BASE
CON 1 CASSETTO E
1 PIANO ESTRAIBILE
60x62 H91

cod.BOFA006



MOBILE DI BASE CON 1
CASSETTO 1 PIANO
SPOSTABILE E 1 PIANO
ESTRAIBILE
60x62 H91

cod.BOFA013

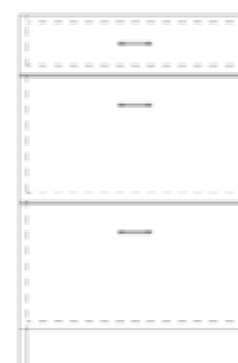

MOBILE DI BASE
CON 1 CASSETTO
PICCOLO E 2
CASSETTI GRANDI
60x60 H91

cod.BOFA014



MOBILE DI BASE
CON 1 ANTA E
2 PIANI INTERNI
SPOSTABILI
60x60 H91

cod.BOFA015



MOBILE DI BASE CON
1 CASSETTO, 1 ANTA
E 1 PIANO INTERNO
SPOSTABILE
60x60 H91

COLORI:



BP
BIANCO



GP
GRIGIO ANTRACITE



cod.BOFA016

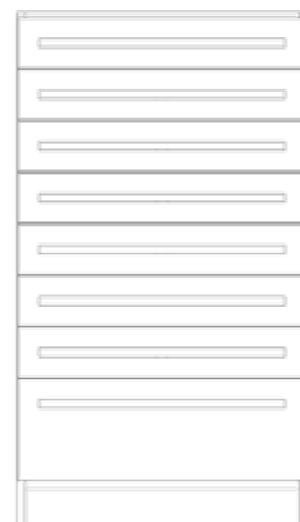

MOBILE HOME CON 8 CASSETTI (7 PICCOLI + 1 GRANDE), COMPLETO DI MANIGLIE (ESCLUSI DIVISORI INTERNI)
65X57 H114,5

cod.BOFA017

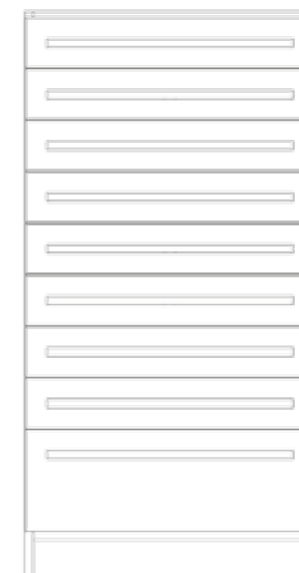

MOBILE HOME CON 9 CASSETTI (8 PICCOLI + 1 GRANDE), COMPLETO DI MANIGLIE (ESCLUSI DIVISORI INTERNI)
65X57 H126

cod.BOFA018



MOBILE HOME CON 8 CASSETTI (6 PICCOLI + 2 GRANDI), COMPLETO DI MANIGLIE (ESCLUSI DIVISORI INTERNI)
65X57 H126

cod.BOFA019



MOBILE HOME CON 9 CASSETTI (7 PICCOLI + 2 GRANDI), COMPLETO DI MANIGLIE (ESCLUSI DIVISORI INTERNI)
65X57 H137,5

cod.BOFA020



MOBILE HOME PER SOTTOBANCO CON 6 CASSETTI (5 PICCOLI + 1 GRANDI), COMPLETI DI MANIGLIONE (ESCLUSI DIVISORI INTERNI)
65X57 H91

COLORI:



BP
BIANCO



GP
GRIGIO ANTRACITE



cod.BOFA025

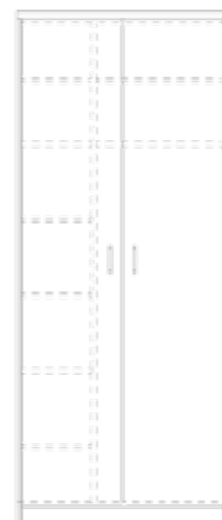

ARMADIO A 2 ANTE
COMPLETO DI DIVISORIO
VERTICALE, PIANI INTERNI
SPOSTABILI E 1 BARRA
APPENDERIA
90X40 H220

cod.BOFA026



ARMADIO A 2
ANTE, COMPLETO
DI 1 PIANO
INTERNO
SPOSTABILE
87X60 H220

cod.BOFA027



ARMADIO PER
SPOGLIATORIO
CON 6 ANTINE
PICCOLE CON
SERRATURE
30X60 H220

cod.BOFA028

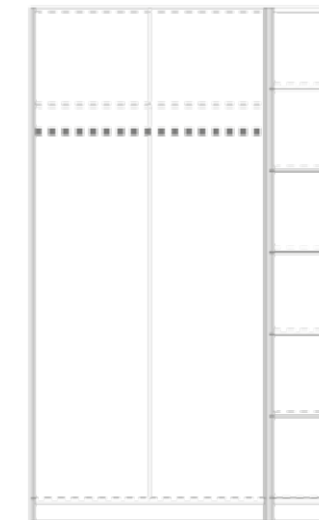

ARMADIO PER SPOGLIATOIO
CON 2 ANTE GRANDI CON
SERRATURE, 6 ANTINE
PICCOLE CON SERRATURE,
E 1 BARRA APPENDERIA
130X60 H220

cod.BOFA021

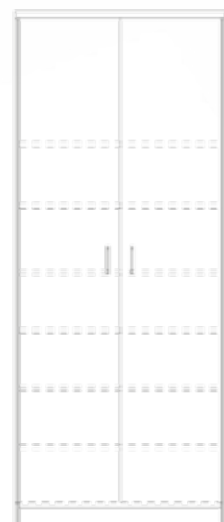

ARMADIO 2 ANTE
CON SERRATURE,
COMPLETO DI
6 PIANI INTERNI
SPOSTABILI
90X40 H220

cod.BOFA022



ARMADIO A 1 ANTA,
COMPLETO DI 1
PIANO INTERNO
SPOSTABILE E 1
BARRA APPENDERIA
50X60 H220

cod.BOFA023

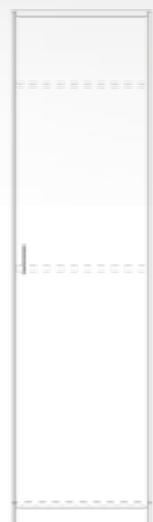

ARMADIO A 1 ANTA,
COMPLETO DI 2
PIANI INTERNI
SPOSTABILI
60X62 H220

cod.BOFA024



ARMADIO A 2 ANTE,
COMPLETO DI 2 PIANI
INTERNI SPOSTABILI
80X62 H220

cod.BOFA029

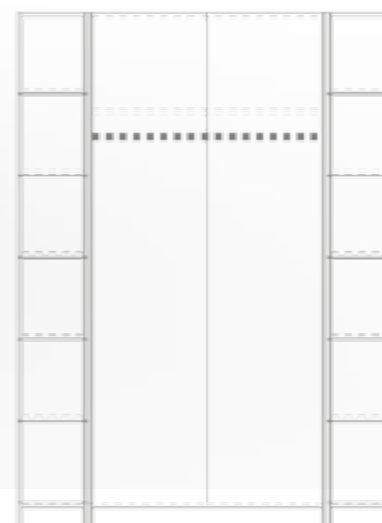

ARMADIO PER SPOGLIATOIO
CON 2 ANTE GRANDI CON
SERRATURE, 12 ANTINE
PICCOLE CON SERRATURE
E 1 BARRA APPENDERIA
160X60 H220

cod.BOFA030



ARMADIO CON 2
ANTE SUPERIORI
GRANDI E 2 ANTE
INFERIORI PICCOLE
CON SERRATURE,
COMPLETO DI 1
PIANO INTERNO E
1 BARRA
APPENDERIA
80X62 H220

cod.BOFA031



ARMADIO CON 2
ANTE SUPERIORI
GRANDI E 6 ANTE
INFERIORI PICCOLE
CON SERRATURE,
COMPLETO DI 1 PIANO
INTERNO E 1 BARRA
APPENDERIA
66X62 H220

cod.BOFA032



ARMADIO A 1 ANTA,
COMPLETO DI 2 PIANI
INTERNI SPOSTABILI
45X52 H220

cod.BOFA033

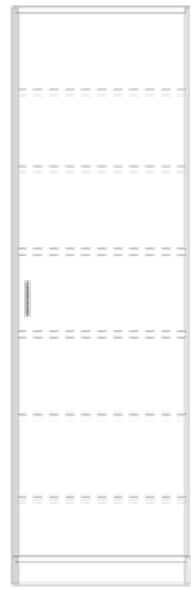

ARMADIO A 1 ANTA
CON 6 RIPIANI
INTERNI SPOSTABILI
60X27 H220

cod.BOFA034

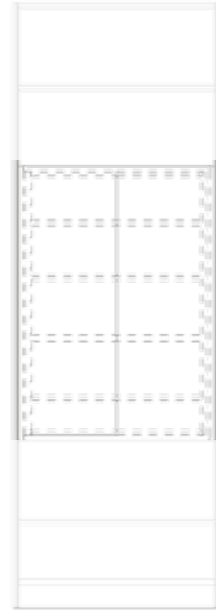

ARMADIO DA INSERIRE
IN MOBILE A GIORNO,
CON 2 ANTE E 4 PIANI
INTERNI SPOSTABILI
62X23 H95

cod.BOFA035

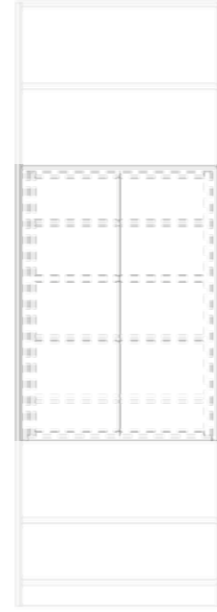

ARMADIO DA INSERIRE
IN MOBILE A GIORNO,
CON 2 ANTE E 4 PIANI
INTERNI SPOSTABILI
62X33 H95

cod.BOFA039



MOBILE A GIORNO
COMPLETO DI 10 PIANI
INTERNI SPOSTABILI
75X30 H220

cod.BOFA040



MOBILE A GIORNO
COMPLETO DI 10 PIANI
INTERNI SPOSTABILI
75X35 H220

cod.BOFA041



MOBILE A GIORNO
COMPLETO DI 10 PIANI
INTERNI SPOSTABILI
75X45 H220

cod.BOFA036

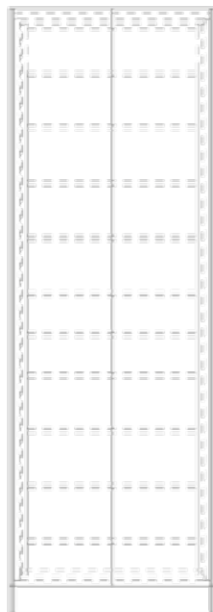

DOPPIO ARMADIO
(1 INSERITO
NELL'ALTRO) AD
ANTE CON
SERRATURE,
COMPLETO DI 10
RIPIANI INTERNI
SPOSTABILI
75X35 H220

cod.BOFA037

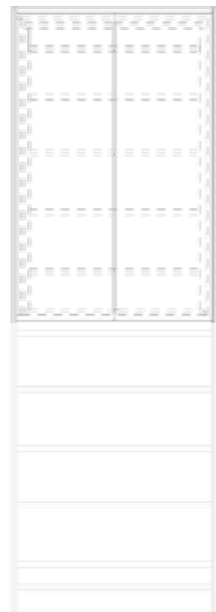

MEZZO DOPPIO
ARMADIO (1 INSERITO
NELL'ALTRO) AD ANTE
CON SERRATURE,
COMPLETO DI 5 PIANI
INTERNI SPOSTABILI
75X35 H110

cod.BOFA038



MOBILE A GIORNO
COMPLETO DI 10 PIANI
INTERNI SPOSTABILI
75X25 H220

COLORI:



BP
BIANCO



GP
GRIGIO ANTRACITE



cod.BOFA042

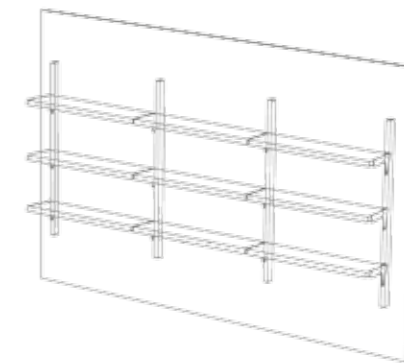
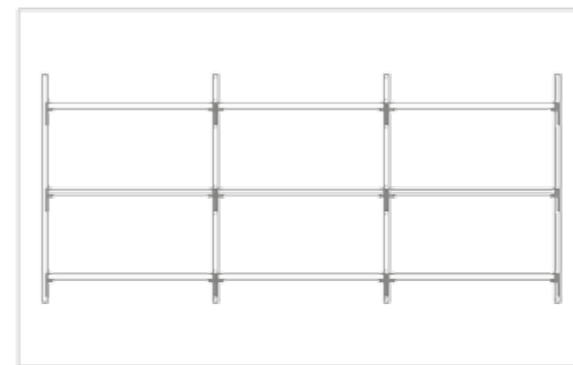

PARETE CON CREMAGLIERE
E 3 LIVELLI DI RIPIANI
200X32 H125cm

cod.BOFA043

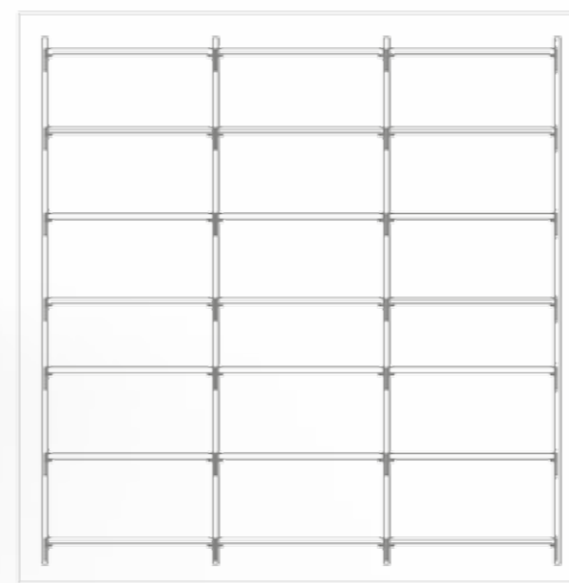

PARETE CON CREMAGLIERE
E 7 LIVELLI DI RIPIANI
200X32 H200cm

COLORI:



cod.BOFA044

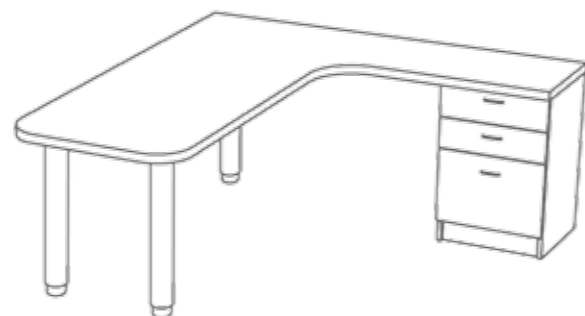
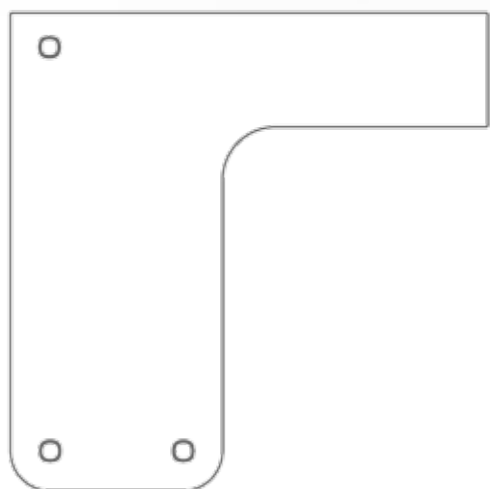

SCRIVANIA AD AN-
GOLO COMPLETA DI
PIANO, CASSETTIERA E
GAMBE IN METALLO
180X180 H75

cod.BOFA045

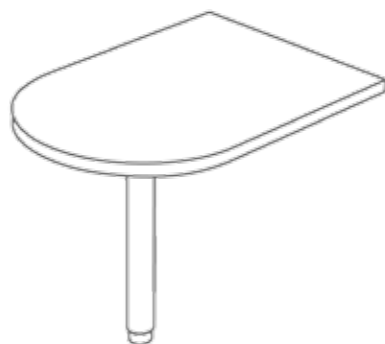
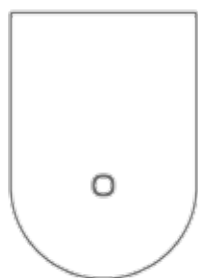

TAVOLO PER CABINA
COMPLETO DI GAMBA
100X70 H75

cod.BOFA046
BANCO GALENICO



cod.BOFA047
BANCO GALENICO

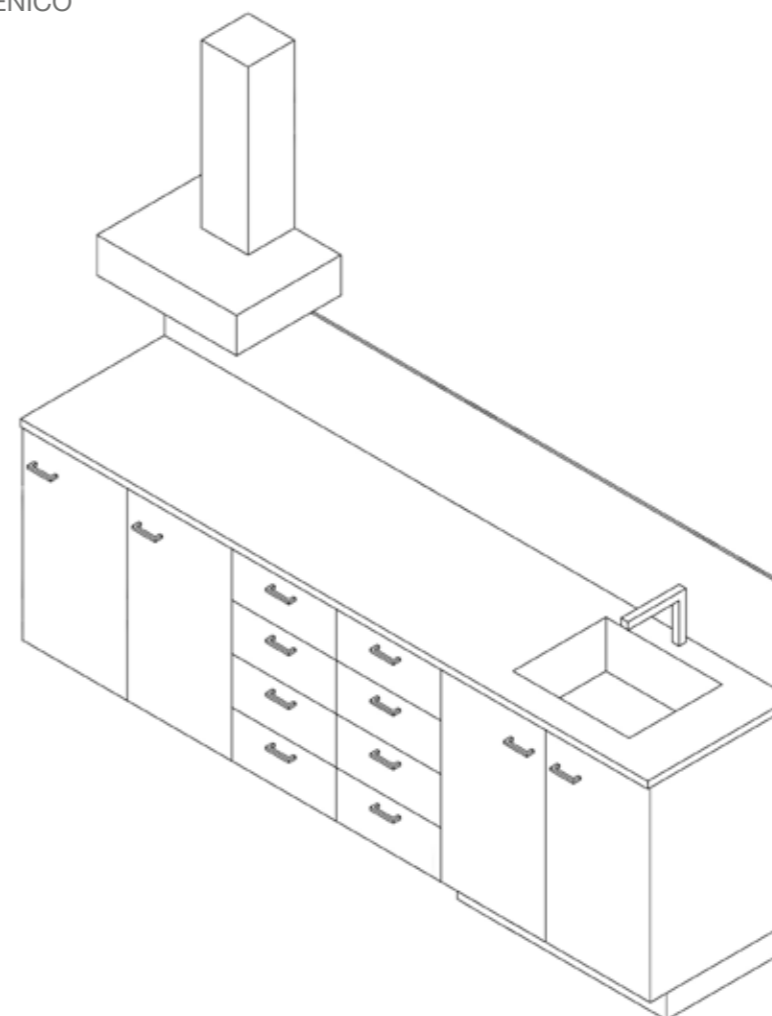

Tutti i diritti sono riservati.
Nessuna parte di questo volume può essere riprodotta,
archiviata o trasmessa in nessuna forma e con nessun
mezzo elettronico, meccanico o altro, senza il consenso di CRC.

*All rights reserved.
No part of this catalogue may be reproduced, stored or transmitted
in any form or by any means, electronic, mechanical or otherwise,
without the permission of CRC.*

Copyright 2019 CRC

Concept: Architetti CRC

Render e grafica: Angela Rimoldi - Designer CRC



 CRC srl - Viale 5 Giomate 1382
21042 Caronno Pertusella (VA)

 Tel. +39 02-96.59.001-2-3

 Fax. +39 02-96.59.004

 Skype: Crc Arredamenti

 Email: crc@crc.it

 www.arredamentifarmaciacrc.it

 Numero Verde
800.685.584

